

FLAT CHIP
THICK FILM (5% • 2%)
GENERAL PURPOSE
RK73 B

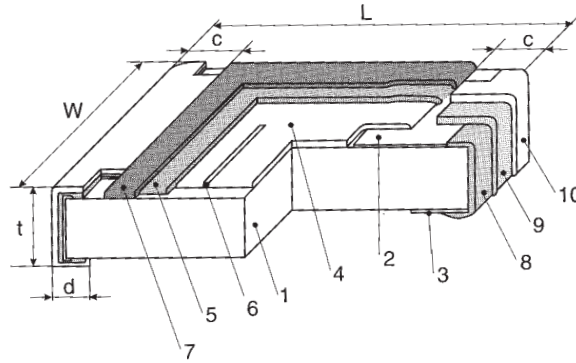

STRUCTURE

1	Ceramic substrate		
2	Top termination (Ag Pd)	~ 11	µm
3	Bottom termination (Ag Pd)	~ 11	µm
4	Resistive layer	~ 11	µm
5	Glass layer	~ 11	µm
6	Trimming cut		
7	Protective layer	~ 25	µm
8	End termination	~ 0.05	µm
9	Diffusion barrier (Ni)	3 ~ 12	µm
10	Solder plating	3 ~ 12	µm

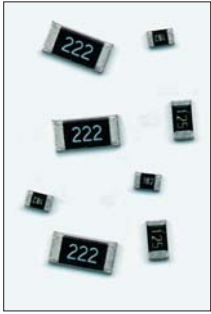

IDENTIFICATION

TYPE	COATING COLOR	MARKING
RK73 1F ... RK73 1E	Black	None
RK73 1J ... RK73 3A		White, 3 digits

TYPE DESIGNATION (HOW TO ORDER)

Old Part No.	RK73K	1J	G	TD	10K		
New Part No.	RK73B	1J		L	TD	G	
	PRODUCT CODE	STYLE	TOLERANCE	TERMINATION SURFACE MATERIAL T: Sn L: Sn/Pb	TAPING*	NOMINAL RESISTANCE 3 digits	TOLERANCE J: ± 5% G: ± 2%

*Please see "PACKAGING"

FEATURES

- RuO₂ thick film resistor element
- Anti-leaching nickel barrier terminations
- Excellent heat resistance and moisture resistance are ensured by the use of metal glaze thick film
- Rated ambient temperature: +70° C
- Taping according to IEC-60 286-3
- Meets or exceeds IEC 60 115, CECC 40 401-802
- Suitable for reflow and wave soldering
- Lab Kit available

DIMENSIONS (mm)

SIZE	TYPE	L	W	c	d	t
01005	RK73 1F**	0.4 ± 0.02	0.2 ± 0.02	0.1 ± 0.03	0.1 ± 0.03	0.12 ± 0.02
0201	RK73 1H	0.6 ± 0.03	0.3 ± 0.03	0.1 ± 0.05	0.15 ± 0.05	0.23 ± 0.03
0402	RK73 1E	1.0 ± 0.1	0.5 ± 0.05	0.2 ± 0.1	0.25 ± 0.05	0.35 ± 0.05
0603	RK73 1J	1.6 ± 0.2	0.8 ± 0.1	0.3 ± 0.1	0.3 ± 0.1	0.45 ± 0.1
0805	RK73 2A	2.0 ± 0.2	1.25 ± 0.1	0.4 ± 0.2	0.3 ± 0.1	0.5 ± 0.1
1206	RK73 2B	3.2 ± 0.2	1.6 ± 0.2	0.5 ± 0.3	0.4 ± 0.1	0.6 ± 0.1
1210	RK73 2E		2.6 ± 0.2			
2010	RK73 2H	5.0 ± 0.2	2.5 ± 0.2			
2512	RK73 3A	6.3 ± 0.2	3.1 ± 0.2			

RATING

SIZE	TYPE	T.C.R. (ppm/K)	POWER RATING	MAX. WORKING VOLTAGE	MAX. OVERLOAD VOLTAGE	RESISTANCE RANGE (E24)		OPERATING TEMPERATURE RANGE
						G (± 2%)	J (± 5%)	
01005	RK73B 1F**	± 250	0.03 W	15 V	30 V	10 Ω ... 1 MΩ	10 Ω ... 1 MΩ	-55° C ... +125° C*
NEW 0201	RK73B 1H	± 400	0.05 W	25 V	50 V	10 Ω ... 10 MΩ	10 Ω ... 10 MΩ	
0402	RK73B 1E	± 400	0.063 W	50 V	100 V	10 Ω ... 10 MΩ	10 Ω ... 10 MΩ	-55° C ... +155° C*
0603	RK73B 1J	± 200	0.1 W			1 Ω ... 9.1 Ω	1 Ω ... 9.1 Ω	
0805	RK73B 2A	± 400	0.125 W	150 V	200 V	10 Ω ... 1 MΩ	10 Ω ... 1 MΩ	
1206	RK73B 2B	± 200	0.25 W	200 V	400 V	10 Ω ... 5.6 MΩ	10 Ω ... 5.6 MΩ	
1210	RK73B 2E	± 400	0.5 W			10 Ω ... 1 kΩ	10 Ω ... 1 kΩ	
2010	RK73B 2H	± 200	0.75 W	200 V	400 V	10 Ω ... 5.6 MΩ	10 Ω ... 5.6 MΩ	
2512	RK73B 3A	± 400	1 W			10 Ω ... 5.6 MΩ	10 Ω ... 5.6 MΩ	

* Please note derating diagram

** Under development

Specifications given herein may be changed at any time without prior notice. Please confirm technical specifications before you order and/or use.

**FLAT CHIP
THICK FILM
RK73**

PERFORMANCE

TEST	TEST CONDITIONS	TYP. TEST RESULTS
Life test at 70° C rated power (P ₇₀)	IEC 60115-1 4.25.1 70° C ± 3° C, 1000 h; 1.5 h On / 0.5 h Off cycle	± (1% · R + 0.05 Ω)
Rapid change of temperature	IEC 60115-1 4.19 - 55° C (30 min) / + 125° C (30 min); 5 cycles	± (0.5% · R + 0.1 Ω)
Damp heat steady state	IEC 60115-1 4.24 56 days at 40° C and 93% relative humidity	± (1% · R + 0.05 Ω)
Endurance at 125° C	IEC 60115-1 4.25.3 + 125° C / 1000 h	± (1% · R + 0.05 Ω)
Short time overload	IEC 60115-1 4.13 6.25 x rated power for 5 sec., but smaller 2.5 x U _{max}	± (1% · R + 0.05 Ω)
T.C.R.	IEC 60115-1 4.8 Cycle: + 25° C / - 55° C / + 25° C / + 125° C / + 25° C	Within specified T.C.R.
Bending test	IEC 60115-1 4.31 Bending: 5 mm (1J, 2A, 2B); 3 mm (1H, 1E); 2 mm (2E, 2H, 3A)	± (0.5% · R + 0.05 Ω)
Solderability	IEC 60068-2-20 235 ± 5° C / 2 ± 0.5 sec.	Terminations > 95% covered with new solder
Resistance to soldering heat	IEC 60115-1 4.18 10 ± 1 sec. at 260 ± 5° C solder bath temperature	± (0.5% · R + 0.05 Ω)

DERATING CURVE

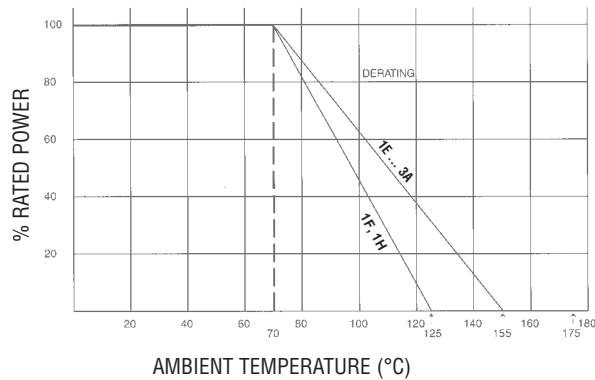

SURFACE TEMPERATURE RISE

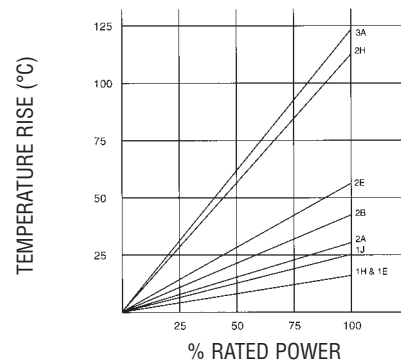

ONE-PULSE LIMITING ELECTRIC POWER

KOA RK73 Flat Chip Resistors

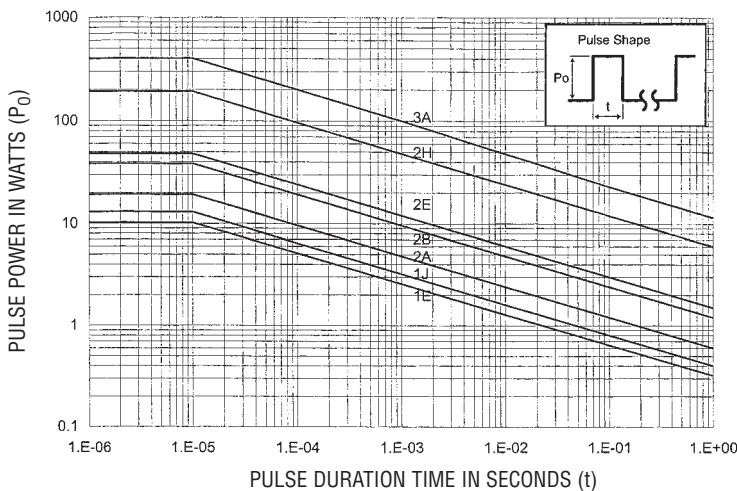

Specifications given herein may be changed at any time without prior notice. Please confirm technical specifications before you order and/or use.

RECOMMENDED PAD DIMENSIONS

FOR REFLOW SOLDERING

TYPE	STYLE	DIMENSIONS (mm)				
		COMPONENT SIZE	A	B	C	D
RK73	1H	0.6 x 0.3	0.25	0.7	0.3	0.225
SG73	1E	1.0 x 0.5	0.5	1.3	0.3	0.4
RN73	1J	1.6 x 0.8	1.0	2.0	0.6	0.5
SR73	1J	1.6 x 0.8	1.0	2.0	0.6	0.5
RK73N	2A	2.0 x 1.25	1.3	2.5	1.05	0.6
LT73	2A	2.0 x 1.25	1.3	2.5	1.05	0.6
NT73	2B	3.2 x 1.6	2.2	4.0	1.4	0.9
PT72	2B	3.2 x 1.6	2.2	4.0	1.4	0.9
LA73	2E	3.2 x 2.5	2.2	4.0	2.3	0.9
CR73	2H	5.0 x 2.5	3.5	6.3	2.3	1.4
RF73	2H	5.0 x 2.5	3.5	6.3	2.3	1.4
KL73	3A	6.4 x 3.2	4.6	8.0	3.0	1.7

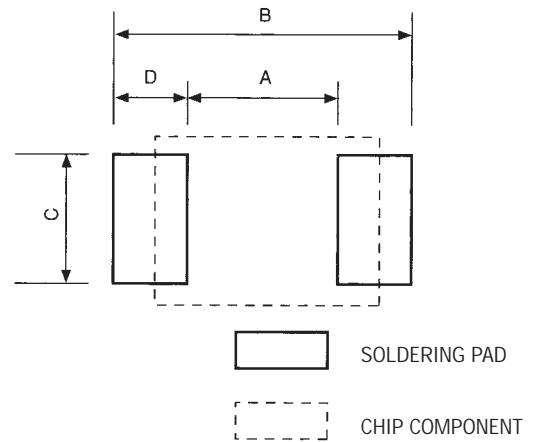

FOR WAVE SOLDERING

TYPE	STYLE	DIMENSIONS (mm)				
		COMPONENT SIZE	A	B	C	D
RK73	1E	1.0 x 0.5	0.5	1.5	0.5	0.5
SG73	1J	1.6 x 0.8	1.0	2.4	0.8	0.7
RN73	1J	1.6 x 0.8	1.0	2.4	0.8	0.7
SR73	2A	2.0 x 1.25	1.3	3.1	1.25	0.9
RK73N	2A	2.0 x 1.25	1.3	3.1	1.25	0.9
LT73	2B	3.2 x 1.6	2.2	4.4	1.6	1.1
NT73	2B	3.2 x 1.6	2.2	4.4	1.6	1.1
LA73	2E	3.2 x 2.5	2.2	4.4	2.5	1.1
CR73	2H	5.0 x 2.5	3.5	6.3	2.5	1.4
RF73	2H	5.0 x 2.5	3.5	6.3	2.5	1.4
KL73	3A	6.4 x 3.2	4.6	8.0	3.2	1.7

RECOMMENDED IR PROFILE (FLAT TYPE COMPONENTS)

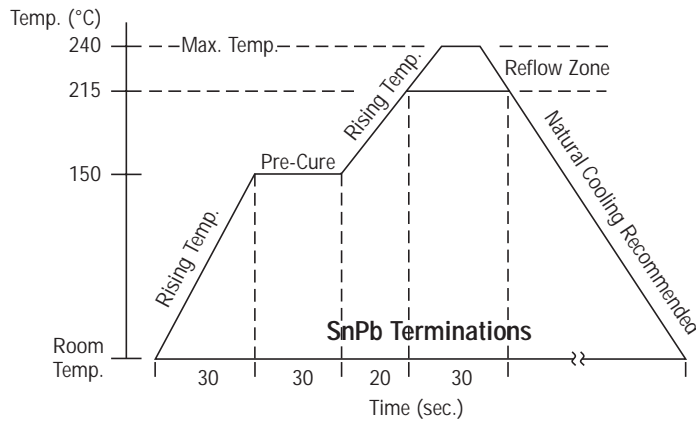

RECOMMENDED WAVE SOLDER PROFILE (FLAT TYPE COMPONENTS)

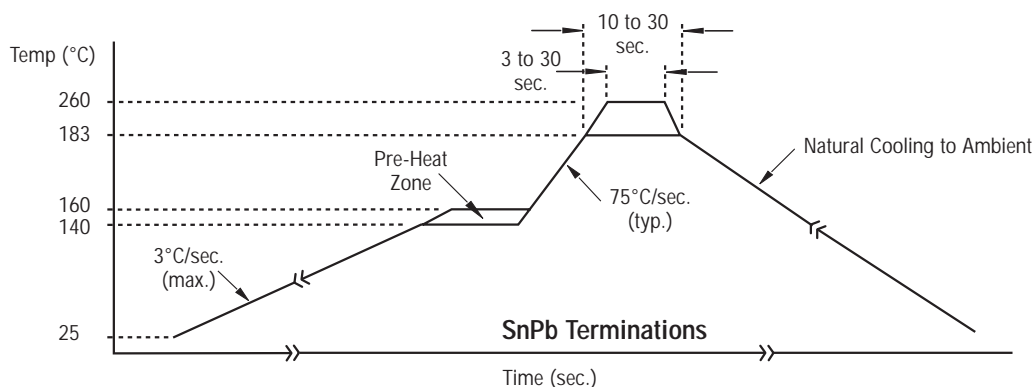

Specifications given herein may be changed at any time without prior notice. Please confirm technical specifications before you order and/or use.

Pour plus d'information, merci de contacter le distributeur en
France :

ISC-DISTREL

1 Avenue du Président Pompidou

BP 50801

92508 Rueil Malmaison Cedex

Tel : 01.41.39.25.00

Fax : 01.47.32.99.25

www.isc-distrel.com

contact@isc-distrel.com